

Non-Spill By-Pass Filter System

Installation and Servicing Instructions

IMPORTANT NOTICE

Read **all** instructions completely before attempting to install this unit. Improper installation could result in serious system and/or equipment damage. The installation of this system is not difficult, however, some mechanical ability is necessary. If you are not comfortable with the instructions or have questions, **do not attempt to install this system**. Consult a mechanic or contact FiltrOil for further instructions or assistance.

If installing on a Japanese or European built vehicle utilizing **Metric** or **B.S.P.** threads, additional parts may be required.

WARNING: This filter system is not designed to replace the engine's normal full-flow filter. Do not attempt to install a by-pass filter element in place of the existing full-flow filter.

WARNING: Extreme care should be taken to avoid bodily harm during installation. Before starting, ensure the engine is cool to avoid burns and **never** work in the engine compartment area with the engine running.

A. Getting started

1. Check all parts against the parts list and inspect for any damage.
2. Make sure you have the tools recommended for the job.

Recommended Tool List

Adjustable Wrench	Torque Wrench	Drill
7/16" wrench	Side Cutter	5/16" drill bit
1/2" wrench	Utility Knife	Center punch
9/16" wrench	Adjustable filter wrench	Hammer
11/16" wrench	Drain oil pan	Vise

B. Attaching the filter mount

1. Survey the engine compartment for possible mounting locations. Solid structures such as the firewall, fender well, radiator support or frame are normal locations. (**Do not mount on Engine.**) Refer to diagram B for minimum area requirements and consider accessibility for servicing.
2. Refer to diagram A for preferred mounting positions.
3. When the location has been determined, use the mounting template provided to locate and mark mounting holes. This can easily be done with a center punch and hammer.
4. Install adapter fittings (EX-224) on filter mounting head (EX-222). If desired, 90° angle fitting (EX-225) may also be used. Using a 7/16" wrench, tighten fittings 2-3 turns beyond finger tight. Keep in mind the direction you wish to have the hoses intersect the mount.
5. With a 5/16" drill bit, drill out the previously marked mounting holes and attach the mount using the 5/16" bolts, nuts, small washer and fender washers provided. Bolts should be tightened to 16-18 foot pounds. 1/2" wrenches or socket will be required for this operation.
6. Lubricate the filter gasket with oil and spin filter onto mount. Tighten per instructions on the filter.

C. Oil Supply

1. Locate oil pressure sending unit (see diagram E). Remove unit and install "T" (EX-230) tightening 2-3 turns beyond finger tight. **Note:** See diagram G if oil pressure sending unit has a 1/4" N.P.T thread. **Note:** Special adapters may be needed to install "T" on some engines. Refer to the Oil Pressure Sending Unit Information Guide. Occasionally, additional fittings may be needed.
2. Reinstall sending unit in one opening of the "T" and a fitting adapter

(EX-225) in the other. Use thread sealant and tighten as noted in C.1. Use 90° Street Elbow (EX-225) if necessary, keeping in mind the direction you wish the hose to intersect the fitting.

3. Measure the amount of hose (EX-232) you will need to run from the Oil Pressure Sending Unit "T" to the filter mount fitting labeled **IN**. Additional length may be required to accommodate engine movement during operation. Using a utility knife, squarely cut the hose to the proper length. **Note:** The hose and fittings supplied with this kit have been matched to provide maximum performance and life expectancy. Interchanging with other types or brands is **not recommended** and **should be avoided**. Should additional hose be required, it may be obtained from FiltrOil by ordering part number EX-232.
4. Install hose fittings (EX-233) on both ends of the hose following the instructions noted in diagram D. Tools required are one 9/16" wrench and one 11/16" wrench or vise.
5. Route and connect the hose assembly making sure the hose does not contact any hot or moving surfaces or sharp edges. Ensure a minimum of a 3/4" bend radius is maintained at all corners (see diagram C). Also, bends in the hose should not begin at hose fittings. Using a 9/16" and 7/16" wrench, tighten hose fitting swivel nut to 130-150 inch pounds or from finger tight, rotate an additional 120° or 1/3 of a turn.

D. Oil Return

1. Remove the existing oil filler cap. (Refer to diagram F)
2. In the center of the cap, drill a 3/8" hole.
3. Install the long threaded portion of the return line swivel fitting (EX-235) into the top of the oil filler cap. Secure with the provided self-locking nut and 9/16" wrench.
4. Measure the amount of hose (EX-232) you will need to run from the return line swivel fitting to the filter mount fitting labeled **OUT**. Additional length will be required to accommodate engine movement during operation. Using a utility knife, squarely cut the hose to the proper length.
5. Install hose fittings (EX-233) on both ends of the hose.
6. Route and connect the hose assembly making sure the hose does not contact any hot or moving surfaces or sharp edges. Ensure a minimum of a 3/4" bend radius is maintained at all corners and hose bend does not begin at fitting. Tighten hose fitting swivel nut to 130-150 inch pounds or from finger tight rotate an additional 120° or 1/3 of a turn.
7. Use plastic ties (EX-234) to secure hoses in position and away from damage. Trim ties, using side cutter. **Note:** Over tightening the plastic ties may cause the hose to collapse and restrict oil flow.

E. Start up procedures

1. Check that all fittings and hoses are securely attached, and that the hoses are routed properly.
2. Check engine oil level. Fill to full mark if necessary.
3. Set vehicle parking brake. With transmission in park/neutral start the engine and immediately check oil pressure. **Note:** Pressure may initially take a moment or two to rise. **Caution:** Carefully check for leaks at fittings, hoses, and mount. If leaks are observed, **STOP ENGINE IMMEDIATELY**, repair leaks and continue.
4. After engine has warmed, shut off and re-check engine oil level. Fill as necessary.
5. Record vehicle mileage/operating hours and date of installation.

F. Periodic Maintenance

1. Periodic visual inspection of the fittings and hoses is recommended. Check for leaks, hose deterioration and cuts. Repair and/or replace as

- necessary.
2. Refer to Recommended Filter Change Interval chart for servicing intervals.
 3. To change the filter element:
 - A. Ensure engine is off and use caution as the engine, oil and filter may be hot and could result in an injury.
 - B. Using a filter wrench, remove the filter element. Dispose of properly.
 - C. Clean the filter gasket contact area on the mount with a clean, lint-free rag.
 - D. Lubricate the new filter gasket with clean oil.
 - E. Screw on new filter, tighten per instructions on the filter.
 - F. Start engine and check for leaks.
 - G. Check engine oil level, fill as needed.
 - H. Record vehicle mileage/operating hours for future reference.

Mounting Angle Diagram A

The filter can be installed in any orientation because of its patented non-spill ability.

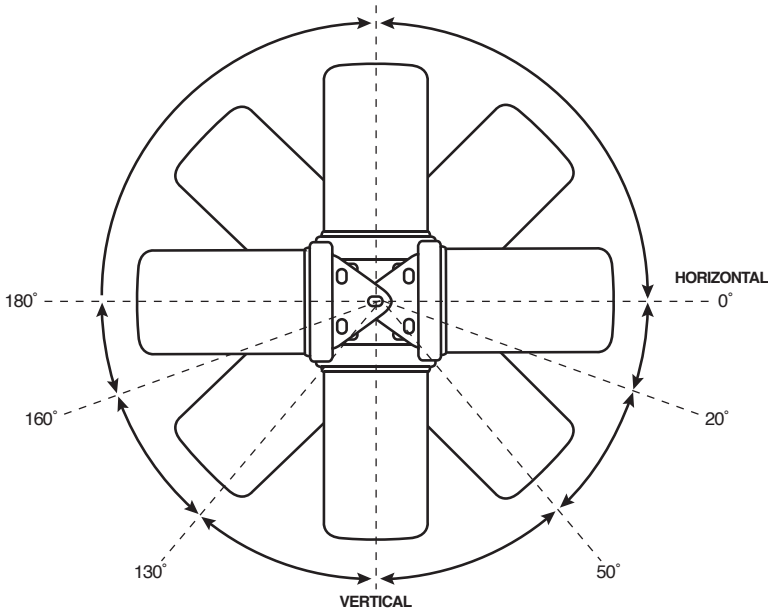

Minimum Area Needed Diagram B

Minimum Area needed for Mount and Oil Filter Element.
 *Mount and Element heights plus 1-inch for removal clearance.

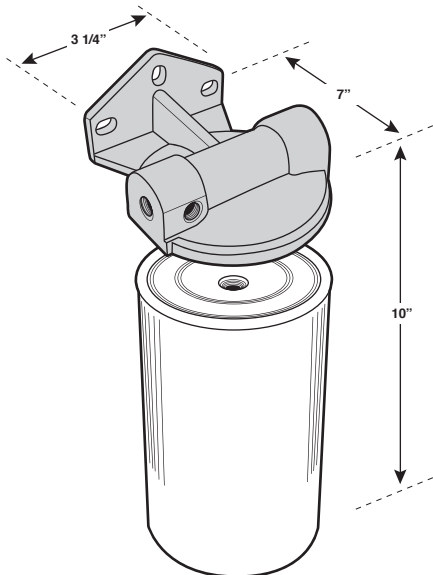

Parts and Assembly List

Non-Spill By-Pass Filter System

Part No.	Description	Qty.
EX-221	Filter	1
EX-222	Filter Mounting Head	1
EX-223	1/8" NPT Hex-Head Plug	1
EX-224	1/8" NPT x 1/4" JIC 37° Flare Straight	2
EX-225	1/8" NPT x 1/4" 90° Elbow	3
EX-226	5/16" x 1" Bolt	3
EX-227	5/16" Washer	3
EX-228	5/16" Fender Washer	3
EX-229	5/16" Nylon Lock Nut	3
EX-230	1/8" Street Tee	1
EX-231	1/8" NPT x 1/4" JIC Needle Valve	1
EX-232	1/4" I.D. Hose	10 ft.
EX-233	1/4" Hose Fitting	4
EX-234	Plastic Tie	2
EX-235	Return Line Swivel Fitting	1
EX-236	1/8" NPT x 1/4" NPT Bushing	1
EX-237	1/4" Street Tee	1
EX-238	Nylon Flat Washer	1
EX-239	1/4" x 1" Nipple	1
EX-240	1/4" Coupling	1
EX-241	1/8" x 1" Nipple	1
EX-242	1/8" x 1" Coupling	1
EX-243	3/8" Nylon Lock Nut	1
EX-244	Gasket for Filter Mounting Head	1
EX-245	Optional Oil Sample Fitting	-

Minimum Bend Radius Diagram C

(Actual Size)

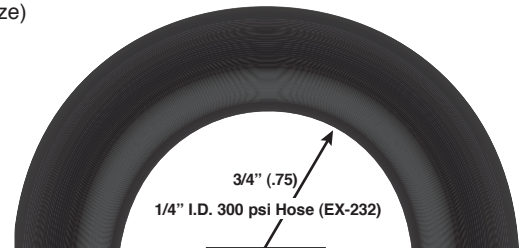

Mounting Template

(Actual Size)

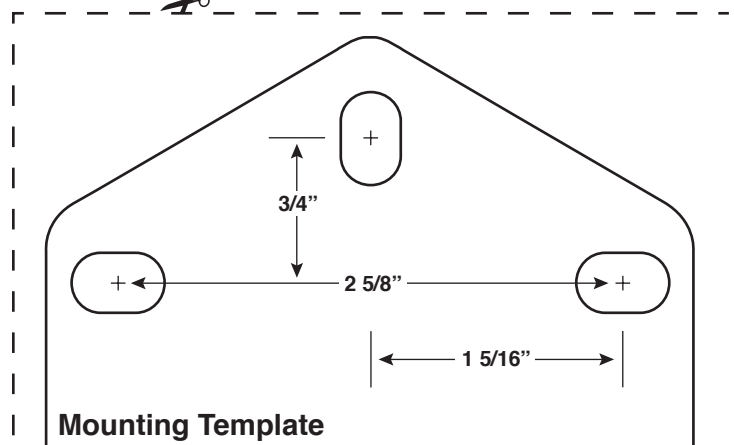

Hose Assembly Diagram D

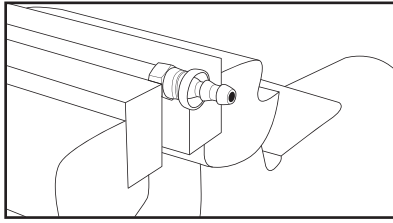

1. Place fitting in vise and apply lubricant to barbed portion of fitting.

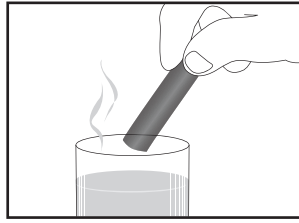

2. Using hot water, warm end of hose.

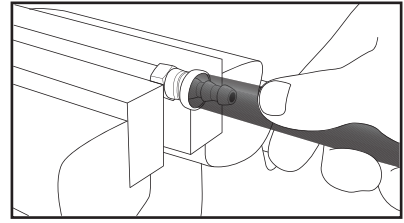

3. Push hose completely on to ensure secure fit.

Installation Diagram E

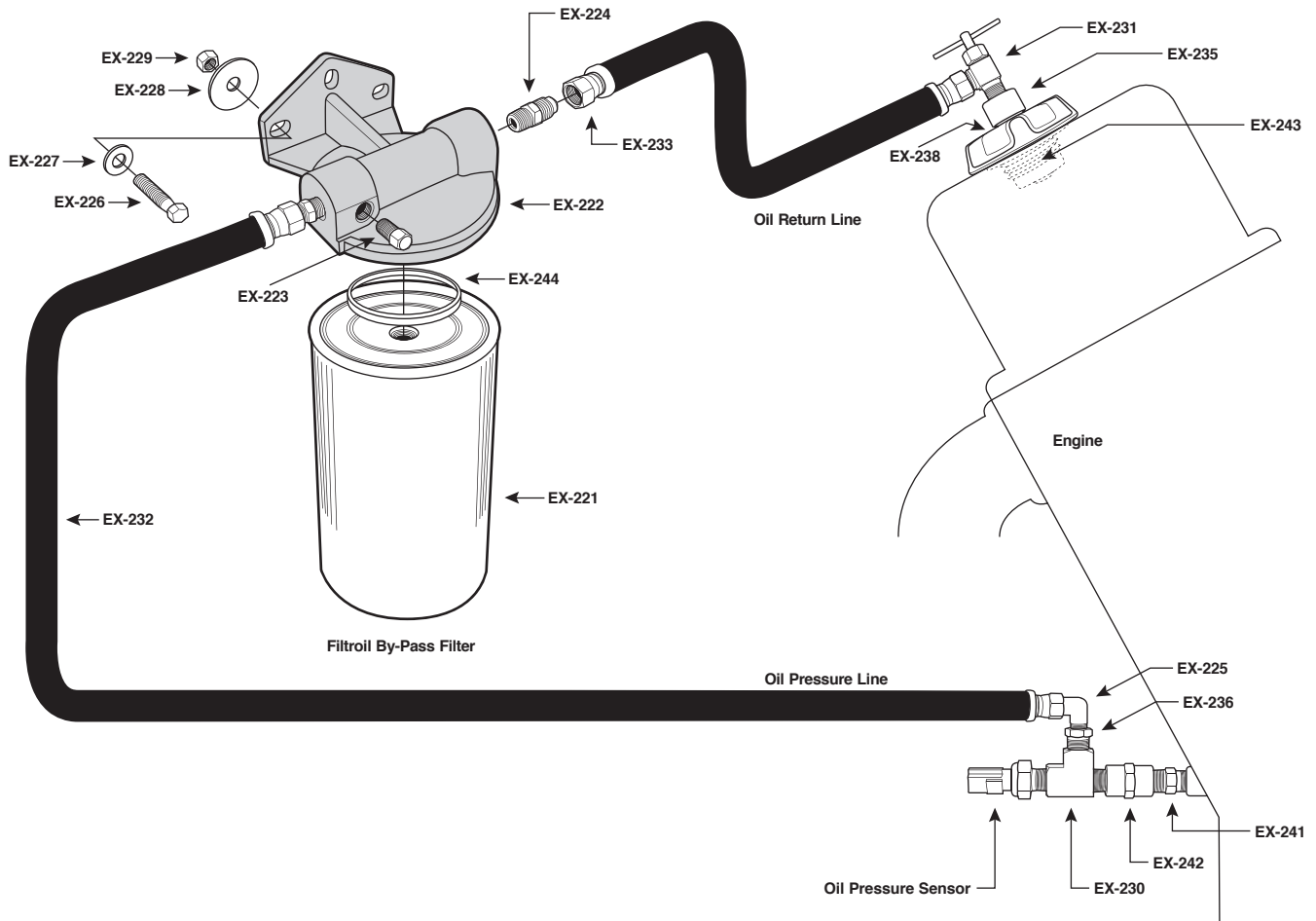

Installing the *Optional* Oil Sample Valve

Getting a clean and uncontaminated oil sample is easy and simple when an oil sample valve is installed onto the Non-Spill By-Pass Filter System. *Optional Oil Sampling Valve (EX-245)* can be ordered from FiltrOil.

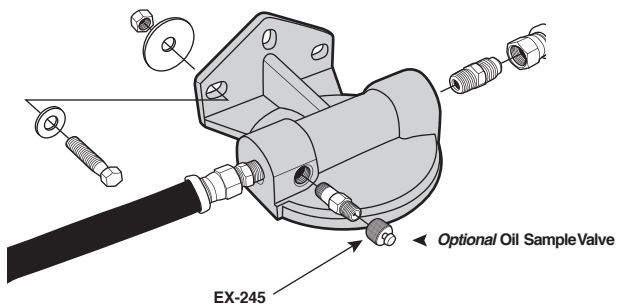

Return Line Fitting & Sampling Valve Diagram F

The Return Line Fitting is designed to be installed directly on your oil filler cap for the oil return-line from the FiltrOil By-pass Filter.

The Return Line Fitting is made of a sturdy brass-alloy and is constructed so that the top of the fixture can swivel. This makes it easy to take off your oil cap. The installation of the fitting is simple and generally takes 5-10 minutes. Once installed, open valve one full turn. **Note:** Be sure there is not a PCV pick-up in this area.

OIL SAMPLING

Close valve. Remove oil filler cap. With engine running, crack valve open and drain sample into container. After sampling is completed, re-install oil filler cap and open valve one complete turn.

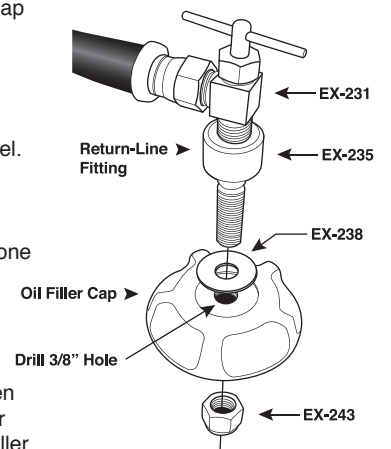

Hose Routing Examples Diagram G

Avoid improper hose movement. Make sure relative motion of the machine components produces bending rather than twisting of the hose. Hose should be routed so that the flex is in the same plane as the equipment movement.

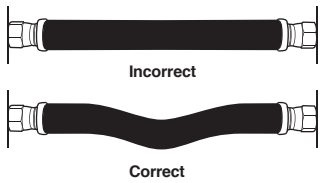

Provide for length change

In straight hose installations allow enough slack in the hose to provide for changes in length that will occur when pressure is applied. This change in length can be from +2% to -4%.

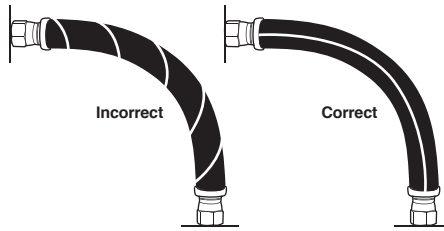

Avoid twisting of hose

Do not twist hose during installation. Pressure applied to a twisted hose can cause hose failure or loosening of connections.

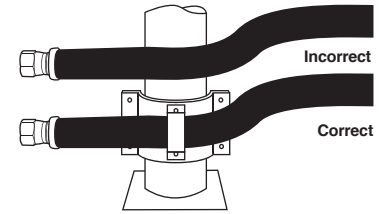

Protect from heat sources

Keep hose away from hot parts. High ambient temperature will shorten hose life. If you cannot route it away from the heat source, insulate it.

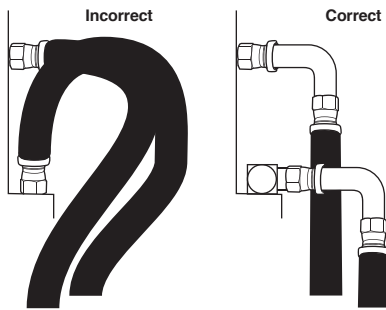

Avoid mechanical strain

Use elbows and adapters when necessary in the installation to relieve strain on the assembly. This will also provide easier and neater installations that are accessible for inspection and maintenance.

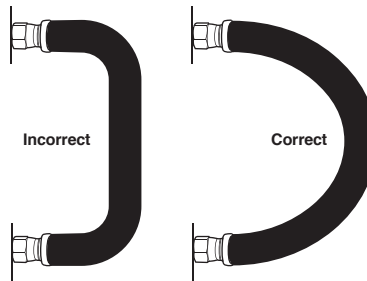

Use proper bend radius

Keep the bend radius of the hose as large as possible to avoid collapsing of the hose and restriction of flow. Refer to Diagram C for minimum bend radius.

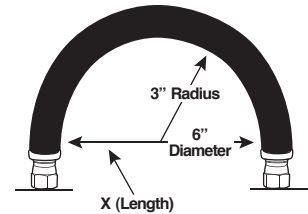

Use proper bend radius (cont.)

Maximum bend radius is measured on the inside bend of the hose. To determine the minimum bend, divide the total distance between ends (X Length) by 2. For example, X = 6, minimum bend radius = 3.

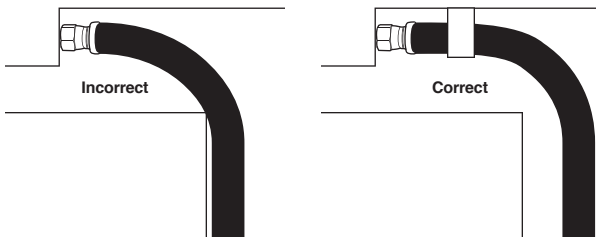

Secure for protection

Install hose runs to avoid rubbing or abrasion. Use clamps to support long runs of hose or to keep hose away from heat or moving parts. It is important that the clamps do not allow the hose to move. This movement will cause abrasion and premature hose failure.

EX-200 Parts Identification

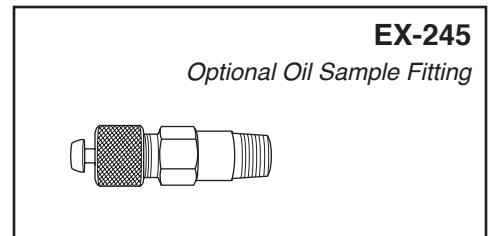
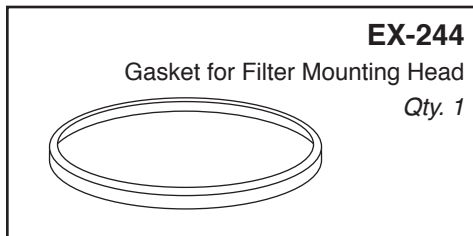
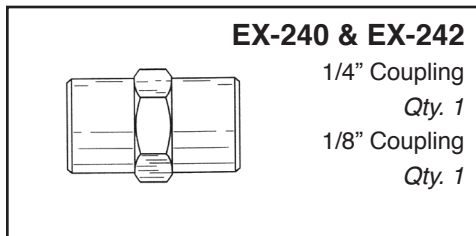
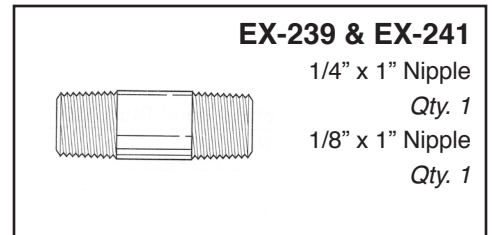
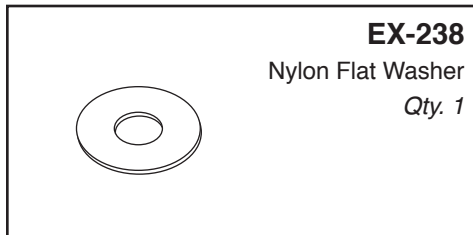
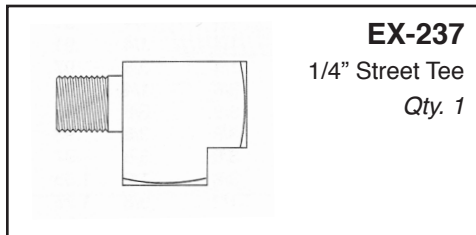
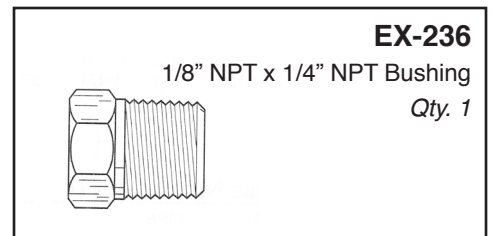
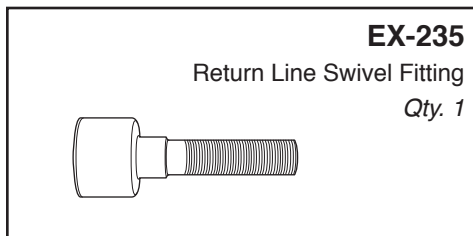
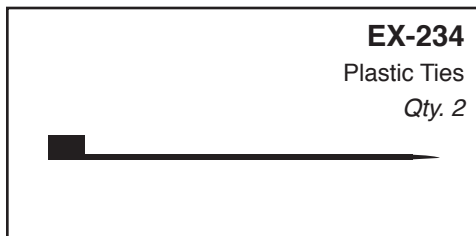
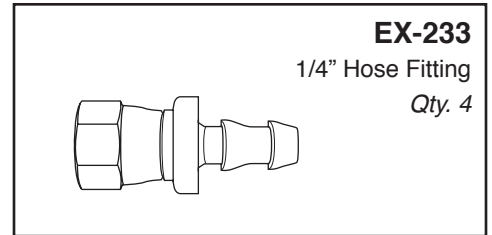
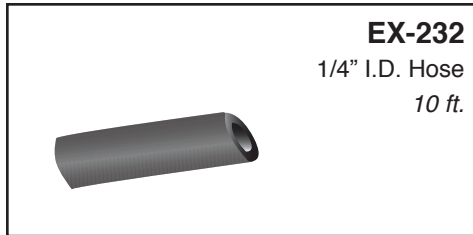
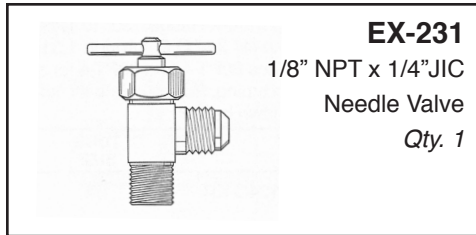
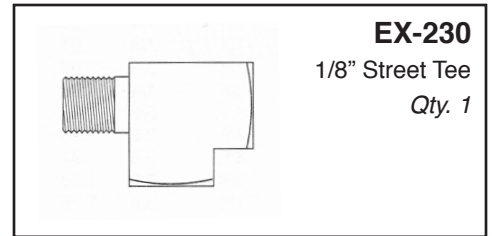
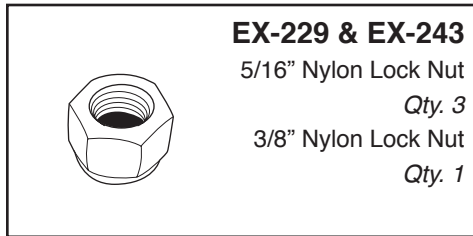
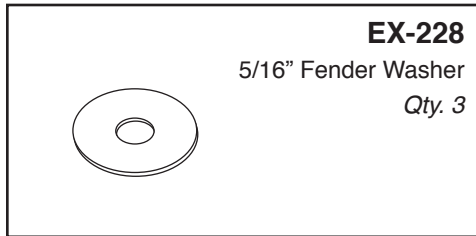
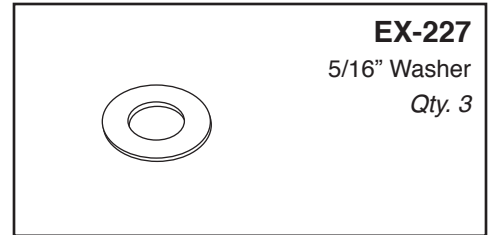
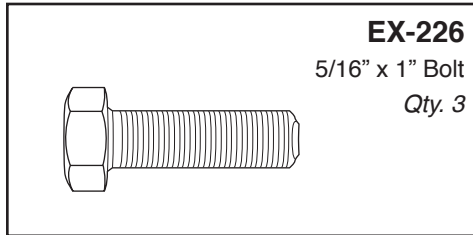
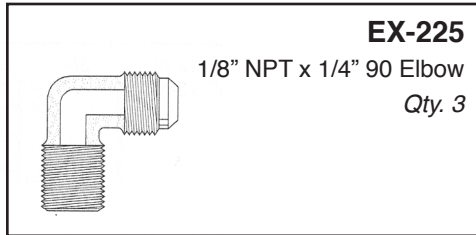
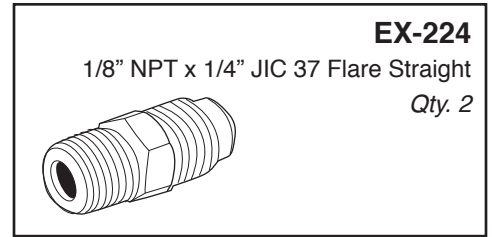
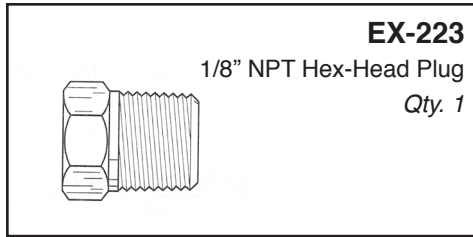
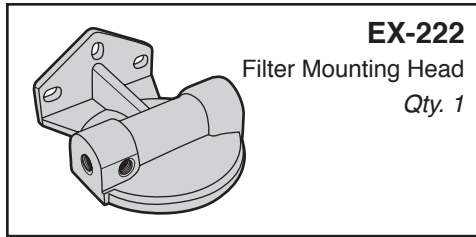

Non-Spill By-Pass Filter System Warranty

Filtroil warrants each EXTENDER Non-Spill By-Pass Filter System to be free of defects in material and workmanship for a period of one year from the time of purchase.

THIS WARRANTY DOES NOT APPLY IF THE NON-SPILL BY-PASS FILTER SYSTEM HAS BEEN IMPROPERLY INSTALLED, ABUSED, DAMAGED, USED IN COMPETITIVE RACING OR ON MODIFIED ENGINES OR IF USED IN ANY AIRCRAFT OF AVIATION APPLICATION. FILTROIL DOES NOT MAKE NON-SPILL BY-PASS RECOMMENDATIONS FOR AIRCRAFT OR AVIATION USE.

If your Filtroil Non-Spill By-Pass Filter System is found to be defective within a period of one year from the time of purchase, Filtroil will replace the Non-Spill By-Pass Filter System or defective component with another Filtroil Non-Spill By-Pass Filter System or component or refund or credit the Dealer's or customer's account. Filtroil will reimburse you for the reasonable costs of the parts and labor required to repair your engine or equipment to the extent the damage was solely attributable to a defect in your Filtroil Non-Spill By-Pass Filter System. In order to obtain engine or equipment repairs under this warranty the Dealer or customer must directly contact,

Filtroil, 2256 Dabney Rd. Ste G, Richmond, VA 23230, Toll Free: 1-800-638-3866, Tel: 804-359-9125, Fax: 804-359-9128.

The customer must allow Filtroil to examine the Non-Spill By-Pass Filter System or Filter(s) and, if required, the engine or equipment, to determine the extent of damage and whether it was caused by a defective Non-Spill By-Pass Filter System or Filter(s). The Non-Spill By-Pass Filter System and Filter(s) must be returned, in its original, undamaged condition, to Filtroil for examination. This warranty is exclusive of any other warranty, express or implied.

FILTROIL NON-SPILL BY-PASS FILTER SYSTEMS EXPRESSLY DISCLAIMS, WITHOUT LIMITATION, THE IMPLIED WARRANTIES OF MERCHANTABILITY AND OF FITNESS FOR A PARTICULAR PURPOSE.

The foregoing states the entire Filtroil Non-Spill By-Pass Filter System's exclusively liability and the buyer's exclusive and sole remedy for any damages or claim made in connection with the sale of a Filtroil Non-Spill By-Pass Filter System. Filtroil Non-Spill By-Pass Filter Systems shall in no event be liable for any special, incidental, or consequential damages whatsoever, except those specifically provided for in this warranty. Some states do not allow the exclusion or limitation of incidental or consequential damages, so the above limitations or exclusion may not apply to you. This warranty gives you specific legal rights and you may also have other rights, which vary from state to state.